



SOLEO®



SB-PF-SOL-003C

INSTALLATION AND USER GUIDE

IMPORTANT SAFETY INSTRUCTIONS,
READ AND FOLLOW ALL OF THE INSTRUCTIONS,
KEEP THESE INSTRUCTIONS

PENTAIR WATER SOLUTIONS SB-CU-IMP-058A (this version 03/2019)



Pentair thanks you for placing your trust in the company and purchasing a SOLEO®, the control automaton for essential swimming pool equipment. SOLEO will automatically control your pool locally.
Please carefully read this user manual to fully benefit from all of the functions of SOLEO®. Store it carefully so that it can be consulted at any time.



Declaration of conformity

Directives – Harmonised standards

Pentair International Sarl - Avenue de Sévelin 18 - 1004 Lausanne - Switzerland

We declare, under our own responsibility, that the product meets the directives

SAFETY EN EN 61010-1:2010
EMC EN 61326-1: EN 301 489-3
EMF EN 62311
RADIO EN 300 220-2

SOLEO (+ PARTS) **PART NUMBERS:**
SB-PF-SOL-003C SB-SE-SOL-003B

Other normative documents

Authorised person for technical documentation

Pentair International S.a.r.l
Avenue de Sévelin 18
1004 Lausanne - Switzerland

Lausanne, 01/04/2019

Guillaume Goussé
European Vice President of Operations



Product specifications: SB-PF-SOL-003C model
Operating temperature: 0° to 40° C
Maximum operating altitude: 2000 m
Main box (internal use): IP 64

Operating hygrometry: 40% at 75° C
Weight (excluding probes): 1.2 kg

Power supply: 230 V ~, 50 Hz



Waste treatment of electronic devices at the end of their service life:

The crossed-out bin placed on the main parts which make up the product indicates that it must not be disposed of with household waste. It must be returned to an appropriate collection point for electronic device recycling (information available from the local household waste collection service). This product contains potentially dangerous substances which may have adverse effects on the environment and human health.

Customer Support: PISA, ITALY (8:30 A.M. to 4:30 P.M.) CET

website: www.pentairpooleurope.com

- Warranty (excluding probes and consumables): 2 years

© 2019 Pentair International LLC, All rights reserved

- The document is subject to change without notice

Trademarks and disclaimers: Soleo® and Pentair® are trademarks and/or registered trademarks of Pentair and/or its affiliated companies. Unless indicated otherwise, names and brands of others that may be used in this document are not used to indicate an affiliation or endorsement between the owners of these names and brands and Pentair. Those names and brands may be the trademarks or the registered trademarks of these parties, or others.

Summary

PRESENTATION

> Safety instructions	p 02
> Content of packaging	p 04
> Description, general operation and functions of the device	p 05

INSTALLATION - SPECIFIC POINTS

> General installation	p 06
> Mounting	p 07
> Electrical installation	p 08
> Connecting the probes	p 10
> Water and air temperature sensors	p 11
> Filtration - connections and settings	p 12
> Sanitizer pump - connections and settings	p 14
> Electrolyser	p 15
> pH pump - connections and settings	p 16
> Radio menu (peering)	p 17
> Assisted washing: Washing support for the filter on the 6-way valve.	p 18
> Time Set menu, Information menu, Languages menu and History menu	p 19

OTHERS

> Navigation menus	p 20
> Assembling pH and ORP probes	p 22
> Updating internal firmware	p 23
> pH / RedOx / chlorine ratio	p 24

IMPORTANT SAFETY GUIDELINES, READ AND FOLLOW ALL OF THE INSTRUCTIONS, KEEP THESE INSTRUCTIONS



GENERAL POINTS

- **DANGER** - INSTALLERS, POOL SPECIALISTS AND OWNERS MUST CAREFULLY READ THESE WARNINGS AND ALL INSTRUCTIONS BEFORE USING THIS PRODUCT.

- **WARNING** - Most countries regulate the construction, installation and operation of public swimming pools and spas, and the construction of residential pools and spas. It is important to comply with these regulations, many of which directly regulate the installation and use of this product. Consult your local building and health codes for more information.

- **ATTENTION** - This installation and user guide contains important information on the installation, operation and safety of this product. This guide should be provided to the owner and/or user of this product.

INSTALLATION

- **DANGER** - RISK OF ELECTRIC SHOCK or electrocution

BEFORE WORKING ON THIS DEVICE - Always cut the supply to the device at the circuit breaker before maintenance. Failure to do this may lead to death or serious injury to service staff, pool users or others, due to an electric shock.

- **DANGER** - SERIOUS BODILY INJURY OR DEATH CAN RESULT IF THIS PRODUCT IS NOT INSTALLED AND USED CORRECTLY.

- **WARNING** - Before installing this product, read and follow the warnings and instructions of this guide. Failing to follow these warnings and instructions may lead to serious injuries, death or material damage. Refer to www.pentairpooleurope.com for more information linked to this product.

- **WARNING** - Connect the device to a differential interrupter. If this system is used to control the underwater lighting devices, a differential interrupter must be installed upstream of these devices. Conductors downstream of the differential interrupter shall not occupy conduits, junction boxes or enclosures containing other conductors, except if the conductors are also protected by a differential interrupter. Refer to valid local codes for more details.

- **WARNING** - This product must be installed by an authorised or certified electrician or a qualified swimming pool professional. All of the applicable installation codes and local regulations must also be respected. Poor installation will create an electrical hazard which could result in serious injury or the death of pool users, installers or others due to electric shocks, and may also cause damage to property.

- **DANGER** - DISCONNECT THE SUPPLY CONNECTIONS BEFORE WORKING ON THIS DEVICE; ELECTRICAL POWER MAY BE SUPPLIED TO THE RELAY TERMINALS FROM OTHER SOURCES.

- **WARNING - CHEMICAL BURN HAZARD:** Make sure all pumps are switched off at the main circuit breakers at the domestic distribution board before drilling into any pipes. Set rules for all handling related to electrical aspects, water and chemical products. Group the supply pumps and chemical product tanks in a safe and secured area.

- **WARNING** - Do not use this product to control an automatic swimming pool cover. There is a risk that swimmers could become trapped under the cover.

- **WARNING** - Devices which are not intended for use in single-family dwellings may require additional safety equipment to comply with local regulations.

- **DANGER** - Except for remote controls, install components at a minimum of at least 1.5 m (5 feet) from the inside wall of the pool or spa.

- **DANGER** - This product is intended for use in swimming pool applications only.

- **ATTENTION** - A sufficient equipotential connection (min. 4.5 mm² recommended), in accordance with local regulations, is obligatory for all metal components of the swimming pool, including the pool pump. This is necessary for the electrical safety as well as reduction of the corrosion risk.

USE

- DANGER - DO NOT LET CHILDREN OPERATE THIS EQUIPMENT.

- **WARNING** - Strictly respect the safety and handling procedures from the acid manufacturers, including protective measures for hands, body and eyes during transferring and using acid. Follow the prescribed safety precautions for handling muriatic acid intended for checking the water pH. Muriatic acid may cause serious physical harm and may damage the swimming pool equipment. Extra care must be taken when installing, maintaining and operating the acid pump feed systems. Acid is dangerous to handle and should be properly contained, transported, poured, stored and dispensed.

- **WARNING** - Check the pH and sanitizer levels of the water before using the pool and make sure the filtration device is not obstructed.

- **WARNING** - Periodically use an independent pH and chlorine testing kit to ensure that the pH and chlorine is at a safe level. If the pH and Oxidation Reduction Potential (ORP) or conductivity probes are broken, depleted or dirty with oils, lotions, or other contaminants, they can report inaccurate results to the system causing incorrect water chemistry, which could harm people or equipment.

- **WARNING** - Consult the device display daily to ensure there are no alarm messages.

- **DANGER** - Water temperatures greater than 37.7° C (100° F) are a health hazard. Prolonged immersion in hot water may induce hyperthermia. Hyperthermia occurs when the internal body temperature exceeds the normal temperature of 37° C (98.6 °F) by several degrees. Hyperthermia may produce the following effects: (1) Unawareness of impending danger. (2) Failure to perceive heat. (3) Failure to recognise the need to leave the spa. (4) Physical inability to leave the spa. (5) Harm to the foetus in pregnant women. (6) Unconsciousness leading to the risk of drowning. The use of alcohol, drugs or medicine is a factor which increases the risk of hyperthermia in hot tubs and spas.

- **WARNING** - When mixing acid with water, ALWAYS ADD THE ACID TO THE WATER. Never add water to the acid. When adding a chemical product to the swimming pool, carefully follow the manufacturer instructions.

- DANGER - DO NOT MIX SODIUM HYPOCHLORITE AND MURIATIC ACID.

- **DANGER** - Keep standard solutions away from children, ensure that the bottles are securely closed, store them in a dry and ventilated location and do not let them freeze. The pH 4 calibration solution is acidic.

Contents of the pack and description

FRONT VIEW

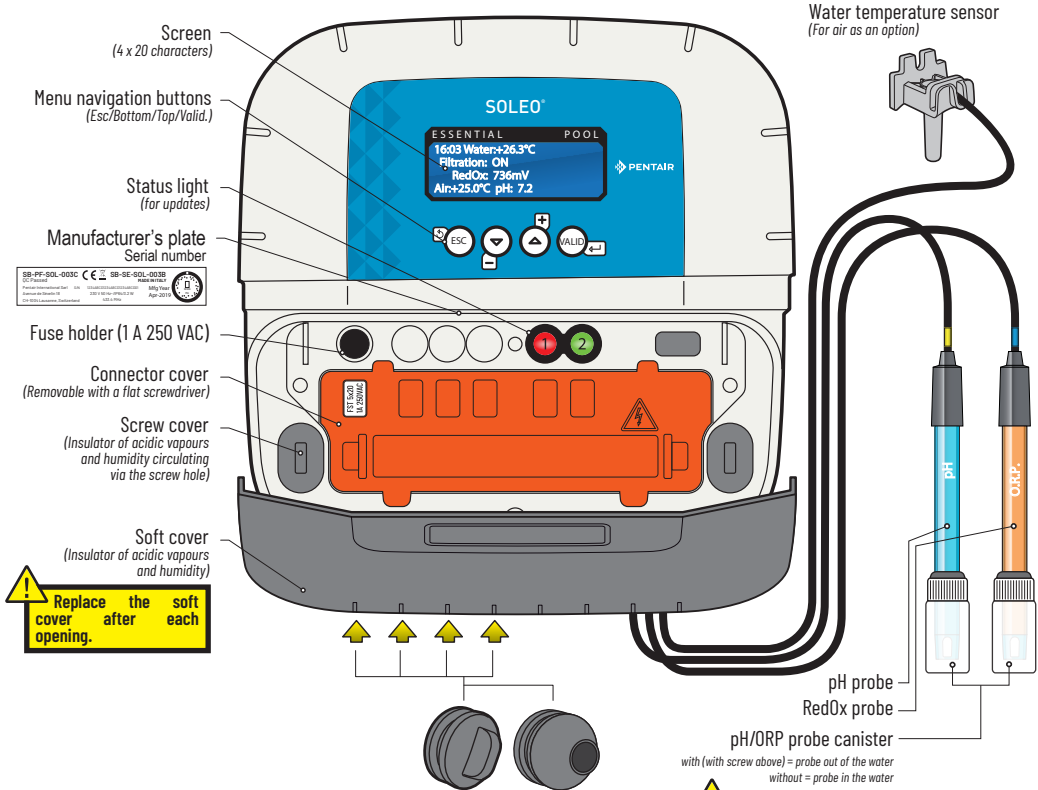

! Replace the soft cover after each opening.



pH4 and pH7 calibration solutions
Necessary for calibrating the pH probe

! The pH4 solution is acidic



USB / mini USB
Update of the software



Clamp band
For mounting the water temperature probe



CABLE GLANDS x 2
Screw thread: 1/2 inch

! The probe caps are filled with potassium chloride. !!! DO NOT DRINK!

Tighten/loosen the probe caps.

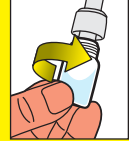

Never push or pull the fitted probe caps of the end plug.

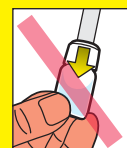

The 2 cable glands are compatible with 1/2" threading for assembly on a bypass. However Pentair advises installing the pH and RedOx probes in a probe holder.

Description

i SOLEO is the brain of the system. SOLEO calculates automatically and controls the operating time of each piece of the equipment.

- Access to information in the technical housing:

- SOLEO supplies the information on a backlit display.

- Control of the equipment in the technical room:

SOLEO supplies the dry contacts to which the classic equipment of the technical room is connected (filtration pump, disinfectant [electrolyser, dosing pump], pH pump).

Please do not use the individual automations of the equipment. SOLEO will start/stop the devices.

If SOLEO is linked to a SPEEDEO, the activation duration of the filter is managed by SOLEO, while the VS pump speeds are managed by SPEEDEO (depending on the events).

- Receiving and processing information:

The probes supply the information required for regulating SOLEO; indeed, at the end of dosing (disinfection, addition of a pH regulator), the probes send a value which makes it possible for SOLEO to refine its settings.

Functions

Filtration control:

- By calculating the time according to the pool temperature (automatic mode).

- By programming a 24 hour cycle (makes it possible to benefit from off hours).

- By integrating the frost protection function (activation of the filtration below 3°C, modifiable value).

- By giving priority to the RedOx regulation (if the value of this reference falls below the set value, the filtration will start on the next hour, on the hour).

- Possibility to select the start time and end time of the filtration in automatic mode (to prevent noise at night).

- Possibility to increase or reduce the filtration time according to the use of the swimming pool (economical mode = pool with a low number of visitors, turbo mode = pool with a high number of visitors) or by default + or - 30% (value can be adjusted).

- Possibility to change into "SHOCK" mode (forcing of the filtration and electrolyser for 24 hours).

Control of a salt chlorinator (or a disinfectant dispenser pump):

- By integrating the information supplied through the RedOx probe.

- Possibility to bring the electrolyser in hibernation at temperatures below 15°C, to prevent premature wear of the electrodes.

Control of a pH pump:

- By integrating the information supplied through the pH probe.

SOLEO also makes it possible to visualise, on its screen (in the technical room):

- instant information from the tank (pH, RedOx, water temperature).

- The functioning durations of the filtration and electrolyser from the current day (since midnight) and from the previous day.

- The functioning durations of the filtration and electrolyser from the previous day (full 24 hours).

Therefore, in summer and winter, you no longer need to worry about your filtration and you limit the interventions in the technical room to a bare minimum.

General diagram (with Speedeo)

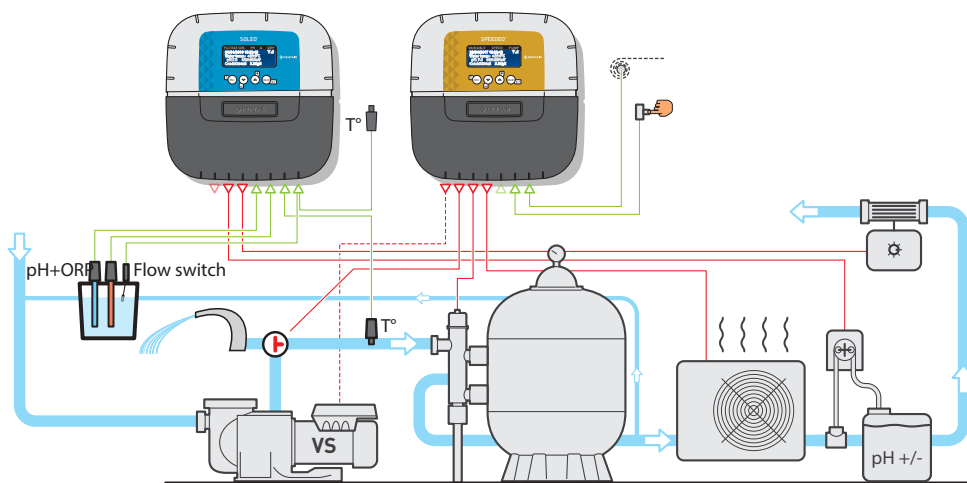

Installation organisation

- i** Installing the probes in an analysis bowl (ref. SB-PD-PRO-005B) which significantly optimises the quality of the measurements and the service life of the probes is recommended. However, SOLEO is supplied with 2 probe holders intended for the receiver columns for quick installation.

- The probe cables must not cross the power cable in the channel.

- The hydraulic network must be linked to the earth to prevent the precision of the probes being altered.

- The probes must be placed after the filter.

- Fully interrupting the flow in the bypass leads to a false reading.

- Upstream/downstream assembly of the filter naturally reduces the flow.

In this case, the pH and ORP probes must be placed vertically on a siphon to keep them humid, even if unprimed.

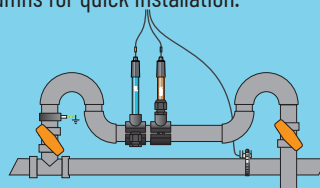

- The probes must be placed before the disinfection and heating.

Back of the device

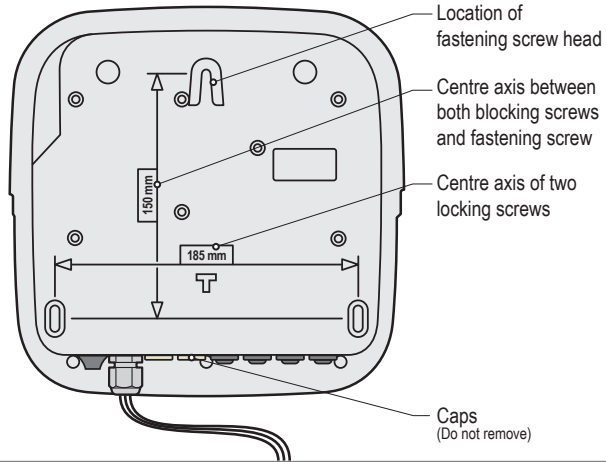

Wall fixing



- This device is intended to be used inside, installed in a technical room which cannot be accessed by children.
- Set the device at a height lower than 2 m using three screws (4 to 5 mm diameter) in appropriate plugs for the type of support and fix the device vertically on a clean support which is able to bear a minimum vertical load of 5 kg.

Pierce three holes in accordance with the below dimensions then place 3 suitable plugs.

- 1 - Tighten the screw at the top, leaving 2 mm under the screw head, then hang the device on this.
- 2 - Place the 2 lower screws.
- 3 - Add the 2 lower screw covers to ensure a full seal.

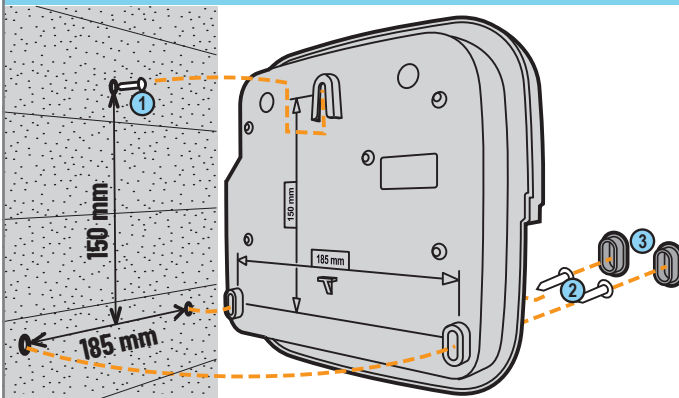

Basis for settings in an existing installation

The 3-position switch is kept.

It makes it possible to rinse the filter using the positions FORCED OPERATION/STOP. If used with SOLEO, position on CLOCK.

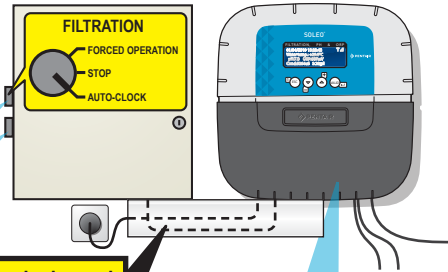

! The supply cable as well as the cables of the dry power contacts must be placed in a plated and closed channel under the device.

SOLEO is connected to a classic electrical installation.

All of the outlets are dry contacts which are normally open (NO) and can interrupt up to 230 V-10 A (above this, add a contactor).

i A safety cover which cannot be unclipped without a tool is positioned above the connectors which provide the voltage. > Place a flat screwdriver on the flat part of clips 2 and 3, while keeping pressure on to unclip it.

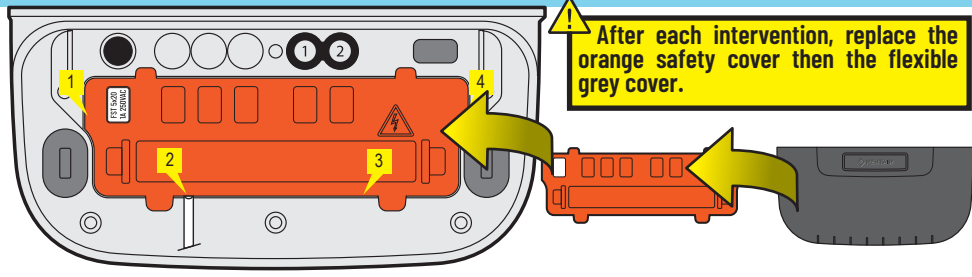

Electrical connections regulation



- The device must be installed by a qualified technician according to valid local regulation
- This device is permanently connected.
- The power supply to the device is cut by its interrupter, which must be close and must remain accessible at all times.
- The device needs to be connected to the earth and its power supply needs to be protected by 16A 30 mA differential protection. This protection must be cut before any intervention on the device.
- Overvoltage category II (2,500 V peak) electrical device. If necessary, place overvoltage protection equipment before the device.
- The device must be placed close to the electrical cabinet to aid connections (3 m max.).

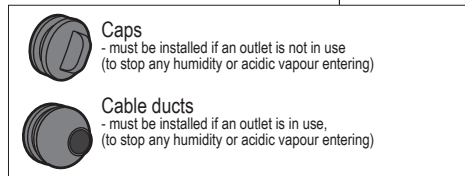
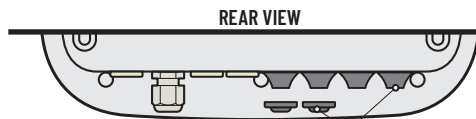
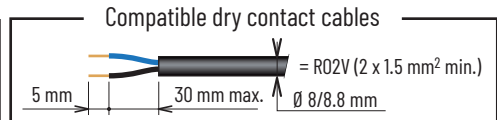
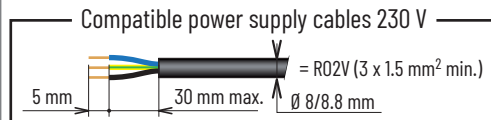
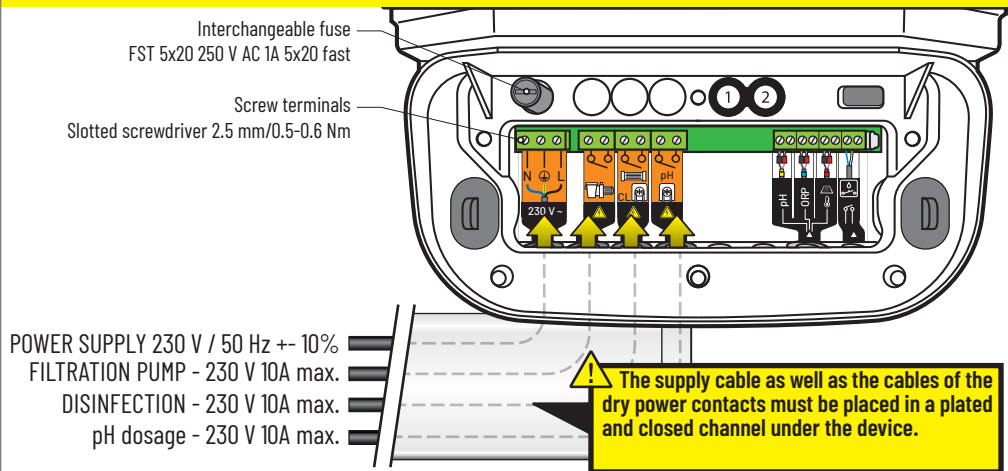

Connection of probes (pH + ORP + temperature)

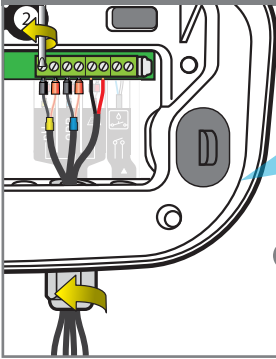

- 1 - Completely unscrew the strain relief bushing: be careful and do not let the black, flexible seal fall.
- 2 - Pass the 3 cables through the screw and strain relief bushing
- 3 - Connect each lug according to the indicator under each terminal block
- 4 - Tighten using a 2.5 mm/0.5-0.6 Nm slotted screwdriver
- 5 - Securely re-tighten the strain relief bushing by hand

i Only Pentair probes are compatible and guarantee proper functioning of the device.

Water and air temperature probes.

- i** SOLEO is supplied with a temperature probe which is suitable for water. It is possible to mount a second temperature probe for the air temperature used to manage the frost protection process of heated technical rooms.

INSTALLATION OF THE WATER TEMPERATURE PROBE

The temperature probe can be installed outside the bypass in front of the filter of the pump or in front of the filter inlet in order to improve the reading precision.

- 1 - Pierce the PVC pipe (diam. 50-70 mm) to a diameter of 10 mm (3/8 inch).
- 2 - Remove the burrs and check the O-ring under the probe.
- 3 - Place the sensor in the hole, then place the clamp band in the groove and tighten.

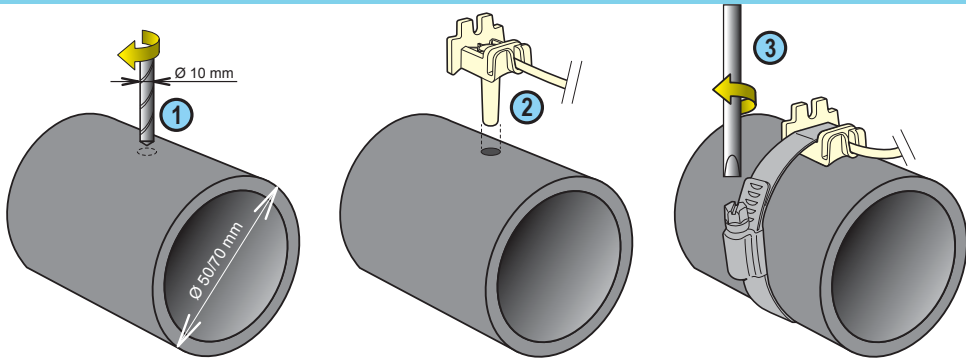

INSTALLATION OF THE AIR TEMPERATURE PROBE (OPTION)

- If the air temperature probe is connected, it automatically becomes the reference value for the management of the anti-freeze protection. The air temperature probe is placed outdoors, away from direct sunlight so that the measurement is not distorted. It can be easily moved due to its 6 m long cable.

- 1 - Mount it on a wall by using screws.
- 2 - Mount it on a horizontal bar of a grate with a cable tie.

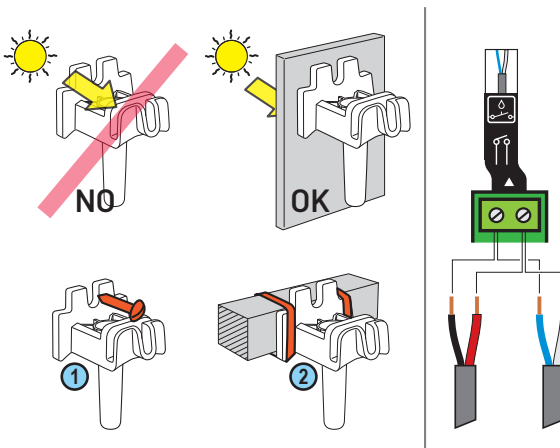

The air temperature probe is parallel connected with the Flow Switch Filtration inlet.

- When the filtration runs, the flow switch signal is the one taken into account. Therefore the swimming pool cannot freeze.

- When the filtration is not on, the air temperature is the one being measured. If it reaches the preset lower limit, then the filtration is started for 60 minutes before a new temperature measurement is taken. After 15 minutes, the filtration is started if the air temperature is still below the designated threshold.

Filtration - connection and settings

i If SOLEO is linked to a SPEEEDO, the SOLEO filtration outlet is only supplied with power when SPEEEDO starts the VS pump (whatever the speed). This SOLEO filtration outlet can for example be used to supply a UV light.

New installation:

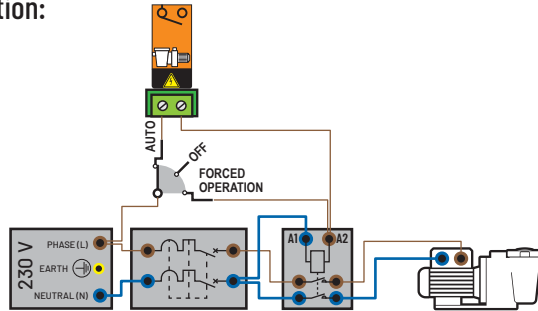

Existing installation:

Parallel connection with the contact of the filtration programmer. > Place the pins into inactive position (OFF).

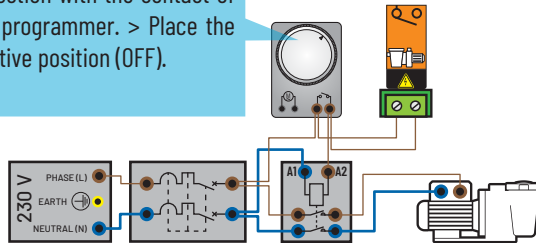

Home menu > Filtration menu:

-Filtration : ON
Start: 07:00
Stop : AUTO
Mode : ECO

Mode: This setting increases or decreases the filtration time to compensate for the size of the pump and/or activity in the swimming pool. Factory settings: Turbo = +30%, Eco = -30% (can be modified in the Instal. menu).

Filtration:

Auto = Automatically calculates the filtration duration according to the water temperature.

On = The filtration runs 24/7.

Off = The filtration is stopped (attention: the freeze-protection mode becomes inactive).

Timer = The filtration will run during the chosen timeframe from start to finish.

Shock = The Shock function triggers 24 hours of forced filtration and electrolysis. This function can be useful after the pool has been used by many visitors and when the pool temperature is high. At the end of Shock mode, SOLEO returns to Auto mode.

If the Timer mode is activated, the line 'Stop:' appears and gives you control of the filtration start and end time, to control the level of noise linked to your pool (filtration noise). By default, leave Stop on Auto.

Connection of a safety filtration feedback system

i To prevent any acid or chlorine being added without any water flow, it is possible to secure the operation of SOLEO by connecting a flow switch after the filtration pump. SOLEO will only start the pH or ORP control (never at the same time) if the contact of this flow switch is closed.

1 - Connect the flow switch to the air temperature inlet in accordance with the diagram. If this input is already in use by a temperature probe, connecting the flow switch in parallel is sufficient.

Secured Install menu (on the main menu, press Esc and Valid at the same time for 3 secs. A star appears in the top right corner of the home screen).

2 - In the Filtration menu, go down to Flow Switch and select: YES.

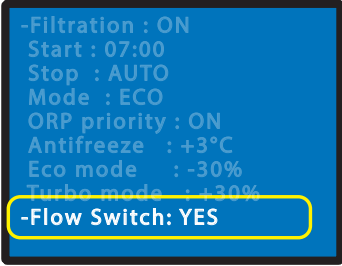

```
-Filtration : ON
Start : 07:00
Stop : AUTO
Mode : ECO
ORP priority : ON
Antifreeze : +3°C
Eco mode : -30%
Turbo mode : +30%
```

-Flow Switch: YES

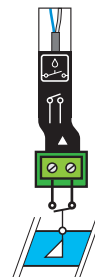

Filtration - Expert menu

i - Secured Install menu (on the main menu, press Esc and Valid at the same time for 3 secs. A star appears in the top right corner of the home screen). This menu, active for 15 min., makes it possible to access the more sensitive functions which are set when the device is put into service.

Home Menu > Filtration instal. menu:

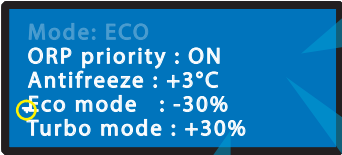

```
Mode: ECO
ORP priority : ON
Antifreeze : +3°C
Eco mode : -30%
Turbo mode : +30%
```

This setting makes it possible to modify the percentage of increase or reduction of the filtration time from 0 to 99%. (Factory settings; Turbo = +30%, Eco = -30%).

To achieve the RedOx (ORP) set point, the filtration will start in 1 hour cycles outside of the authorised hours (because this equipment needs to function when the filtration is on).

Below this temperature, the filtration runs 24/7 to prevent the pool from freezing (active wintering).

- If the air temperature probe is connected: this will be the reference value for managing the freeze protection. Place it outdoors, out of direct sunlight so that the measurements are not distorted (see p06).

- If the air temperature probe is not connected: it is the water temperature probe which becomes the reference value for managing the freeze protection. Please check that the technical room is not heated or has a significantly different temperature in comparison with the temperature outside. If this is the case, adding the temperature difference at +3.0°C is appropriate to compensate for this difference.

Connection and configuration of a 220 V dosing pump for disinfectant at the disinfection outlet.

i The disinfection outlet is valid for any type of disinfection. It is a dry contact and does not supply any voltage.

- 1 - Connect the cables in accordance with the diagram.
- 2 - Select AUTO in the sub-menu Disinfectant/Mode so that the dosing pump supplies the disinfectant until the set value is reached. OFF completely stops the disinfection.
- 3 - Select in the Disinfectant/Set-point sub-menu the value (in mV, by default 700 mV, see the bottom of this page) that needs to be reached.
- 4 - If required, selecting Priming and pressing on Valid. manually starts the connected pump as long as Valid. remains pressed in.
 - Enter the secured Install menu (on the main menu, press Esc and Valid at the same time for 3 secs. A star appears in the top right corner of the home screen).
- 5 - In the Disinfectant/Type sub-menu, select PUMP to indicate that the disinfection is not done by an electrolyser.
- 6 - In the Disinfectant/Stop threshold sub-menu, modify the temperature limit below which the pump will no longer function, which is 16 °C by default).
- 7 - In the Disinfectant/Injection sub-menu, modify the duration of each injection (from 1 to 255 secs, by default 15 secs) performed every 15 minutes.
- 8 - In the pH/Max. volume sub-menu, modify the maximum daily injectable volume (from 0.1 to 9.9 l, by default 0.5 l) for a pump with a flow rate of 1 l/h.
- 9 - In the Disinfectant/Alert range sub-menu, modify the value of the gap (positive or negative) for an alert (flashing) to be triggered in relation to the set value. For example, in case of a RedOx setpoint at 700 mV, with an alert threshold at 100, the RedOx value will flash on the home screen if it reaches or exceeds 600 mV or 800 mV.

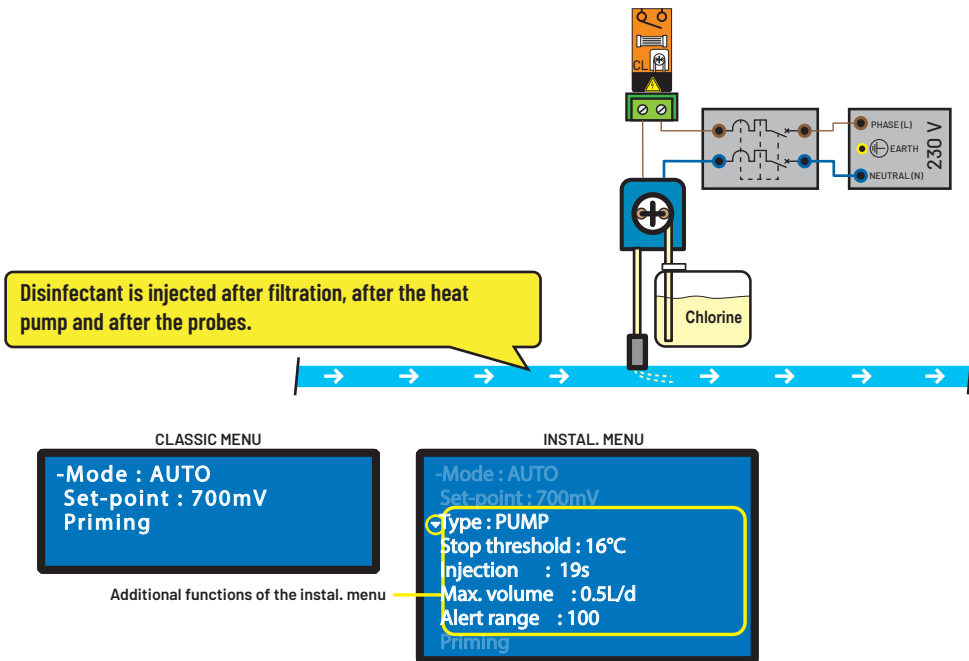

i The RedOx/ORP (oxidation reduction potential) is the disinfectant concentration level (chlorine, bromine, active oxygen, etc.) present in the pool. Keeping within 650 mV and 750 mV is recommended for this 'disinfection power' measurement. The oxidation reduction potential indicates the oxidiser quality present in the water. It is the result of the disinfectant quantity/pollution quantity ratio.

16:03 Water:+26.3°C
 Filtration: ON
 RedOx: 261mV
 Air:+25.0°C pH: 7.2

⚠ A RedOx WHICH IS TOO HIGH IRRITATES SKIN AND MAY DAMAGE PARTS OF YOUR POOL. A RedOx WHICH IS TOO LOW MAY BE A HYGIENE HAZARD

> ensure that: the canister has been removed from the RedOx probe (see p04) and that the RedOx probe is not clogged (see p22)

> manual regulation (OFF position): > Add the disinfectant (chlorine, bromine, active oxygen, etc.) until the desired value is reached.

Connection and configuration of an electrolyser.

i The disinfection outlet does not supply any power.

- 1 - Connect the safety switch (flow switch or 3rd electrode) in series, in accordance with the diagram.
- 2 - In the Disinfectant/Mode sub-menu, select AUTO so that the electrolyser produces chlorine until the set point has been reached. OFF completely stops the disinfection.
- 3 - In the Disinfectant/Setpoint sub-menu, select the set point (in mV, by default 700 mV, see previous page) to be reached.
 - Enter the secured Install menu (on the main menu, press Esc and Valid at the same time for 3 secs. A star appears in the top right corner of the home screen).
- 4 - In the Disinfectant/Type sub-menu, select Electrolysis to signify that the disinfection is done by an electrolyser.
- 5 - In the Disinfectant/STOP limit sub-menu, modify the maximum water temperature before the electrolyser can no longer function (+16.0 °C by default: this is a safeguard to prevent premature wear of the plates). The selection of a very low value will make it possible to prevent a clash with the electrolyser's own safety).
- 6 - In the Disinfectant/Alert Range sub-menu, modify the value of the difference (positive or negative) based on which an alert (flashing) will be triggered in relation to the set value. For example, in case of a RedOx setpoint at 700 mV, with an alert threshold at 100, the RedOx value will flash on the home screen if it reaches or exceeds 600 mV or 800 mV.

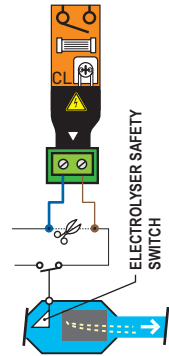

CLASSIC MENU

-Mode : AUTO
 Set-point : 700mV
 Priming

Additional functions of the instal. menu

INSTAL. MENU

-Mode : AUTO
 Set-point : 700mV
 Type : ELECTROLYSE
 Stop threshold : 16°C
 Alert range : 100
 Priming

Connection and configuring a 220 V pH corrector injection pump.

The pH pump outlet is a dry contact and does not supply any voltage.

- 1 - Connect the cables in accordance with the diagram.
- 2 - In the pH/Mode sub-menu, select AUTO so that the dosing pump supplies the pH corrector until the set value is reached. OFF completely stops the pH control.
- 3 - In the pH/Set Point sub-menu, select the value required (see the bottom of this page), by default 7.2.
- 4 - If required, selecting Priming and pressing on Valid. manually starts the connected pump as long as Valid. remains pressed in.
 - Secured Install menu (on the main menu, press Esc and Valid at the same time for 3 secs. A star appears in the top right corner of the home screen).
- 5 - In the pH/Type sub-menu, select PUMP to signify that disinfection will not be carried out by an electrolyser.
- 6 - In the pH/Stop threshold sub-menu, modify the temperature limit below which the pump will no longer function, which is 16 °C by default).
- 7 - In the pH/Injection sub-menu, modify the duration of each injection (from 1 to 255 secs, by default 15 secs).
- 9 - In the pH/Max. volume sub-menu, modify the maximum daily injectable volume (from 0.1 to 9.9 l, by default 0.5 l).
- 9 - In the Disinfectant/Alert range sub-menu, modify the value of the gap (positive or negative) for an alert (flashing) to be triggered in relation to the set point. For example, for a pH set-point value of 7.3, with an alert range at 0.4, the pH value will flash on the welcome screen if it reaches or exceeds 6.9 or 7.7.

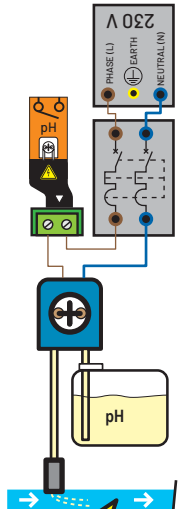

pH corrector is injected after filtration, after heating pump, and after the probes.

CLASSIC MENU	INSTAL. MENU
-Mode : AUTO Set-point : 7.2 Priming	-Mode : AUTO Set-point : 7.2 Type : pH- Stop threshold : 16°C Injection : 19s Max. volume : 0.5L/d Alert range : 0.3 Priming

Additional functions of the Install menu

The pH is a scale (without any units) measuring the acidity (0 to 7) or the alkalinity (7 to 14) of the pool. The pH is the concentration of the hydrogen ions. For a swimming pool, the ideal pH which is generally advised is close to 7.3 (to be confirmed by your swimming pool supplier according to your installation). The precision of the pH measurement is very closely associated with regular pH probe maintenance. Calibrating before the summer season is recommended (see p17).



16:03 Water: +26.3°C
 Filtration: ON
 RedOx: 061mV
 Air: +25.0°C pH: 7.2

A TOO HIGH OR LOW pH IRRITATES SKIN
 > ensure that: the canister has been removed from the pH probe (see p04), or that the pH probe was calibrated less than 6 months ago (see p17), or that the pH probe is not clogged (see p22). > manual control: select 'pH-' or 'pH+' product according to the type of pH deviation.

If the pH value suddenly becomes inconsistent, check if an air bubble at the bottom of the pH probe is resulting in a bad measurement. Shake the probe (as for a mercury thermometer) so that any air bubbles rise up by the centrifugal force.

Calibration menu (pH probe)

- Calibrating the pH probe before the bathing season is strongly advised, and then every 3 to 6 months after this. The service life of a pH probe is 18/24 months on average, according to the flow which passes through the probe. The Pentair pH probe is available from your swimming pool supplier.

Welcome menu > calibration menu :

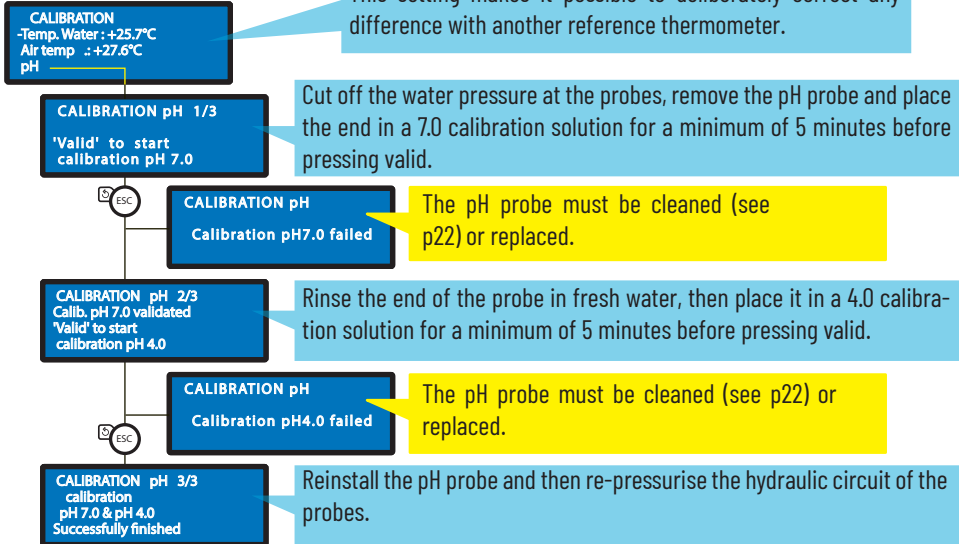

Radio menu (radio pairing between SOLEO and SPEEDED)

16:03 Water: +26.3°C
Filtration: ON
RedOx: 736mV
Air: +25.0°C pH: 7.2



This symbol (antenna) indicates that SOLEO is connected to a SPEEDED.

- This menu can only be accessed at SOLEO. The default radio channel is Channel 01 (same for SPEEDED). The devices have a range of 30 m. A SOLEO and a SPEEDED set on the same radio channel and at a distance maximum 30 m will automatically be paired. If several different installations are close to each other, it is possible to shift the radio channel of one of the installations to one of the other 9 channels (2 to 10) to prevent interference. It is therefore important to choose the same channel number on the 2 devices to be paired.

Home menu > Radio menu :



- If SOLEO is linked to a SPEEDED, the SOLEO filtration outlet is only supplied with power when SPEEDED starts the VS pump (whatever the speed). This SOLEO filtration outlet can for example be used to supply a UV light.

Assisted backwash: Backwash support for the filter on the 6-way valve.

i SOLEO supports you in washing the filter by chronologically proposing the different required steps.

Welcome menu > filtration menu:

```
-Manual Backwash
backwash  :10 s
Rinsing   :20 s
```

On the **Filter washing** sub-menu, enter the desired washing period (factory pre-set at 70 secs) and enter the desired rinsing duration (factory pre-set at 20 secs). These durations can be personalised by following the recommendations for your installation.

Filtration menu > Manual backwash:

```
|||||
| 'Valid' to |
| start washing |
|||||
```

Press **VALID** to start the procedure.

```
|||||
|Put into position |
| backwash +'Valid'|
|||||
```

Put the 6-way valve in the **Washing position** and then hold it down **VALID**.

```
|||||
| Washing in |
| progress 7secs|
|||||
```

SOLEO starts the filtration pump for the length of time entered into the field **backwash: 70 s**.

```
|||||
| Stop |
| filtration |
|||||
```

SOLEO stopped the filtration pump. This display only remains for 2 seconds.

```
|||||
|Put into position |
| Rinsing +'Valid'|
|||||
```

Put the 6-way valve in the **Rinsing position** and then hold it down **VALID**.

```
|||||
| Rinsing in |
| progress 17secs|
|||||
```

SOLEO starts the filtration pump for the length of time entered into the field **Rinsing: 20 s**.

```
|||||
| Stop |
| filtration |
|||||
```

SOLEO stopped the filtration pump. This display only remains for 2 seconds.

```
|||||
|Put into position |
|Filtration + Valid|
|||||
```

Put the 6-way valve in the **Filtration** and then hold it down **VALID**. The procedure is finished.

Time setting menu:

- i** This adjustment makes it possible to set the time of the device. If the power supply is interrupted for more than 30 min., reinstalling the time is necessary.

Welcome menu > Time setting menu :

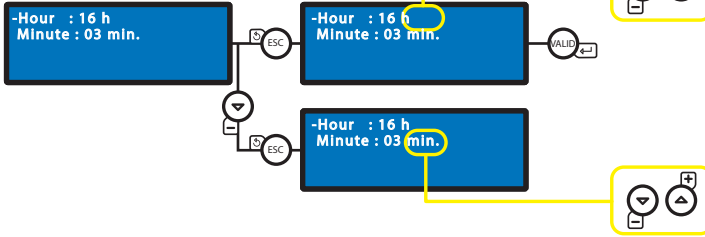

Information menu

- i** This menu makes it possible to find the SOLEO OS version.

Welcome menu > Information menu:



Language menu

- i** This menu makes it possible to select a language

Welcome menu > language menu:



History menu

- i** This menu makes it possible to find the daily and previous day's activity of each connected piece of equipment.

1 - Access the secured DAILY HISTORY menu by pressing Return:



Navigation menus (1/2)

- Filtration

- _____ Filtration: AUTO, SHOCK, TIMER, OFF, ON
- _____ Start: 07:00
- _____ End: Auto
- _____ mode: Eco, Normal, Turbo
- _____ ORP priority: ON, OFF
- _____ Frost prevention: +3 °C
- _____ Algorithm: t=T VS, BlueVS, T/2Cl₂, BluCl₂
- _____ Eco mode: -30%
- _____ Turbo mode: +30%
- _____ Flow switch: YES, NO

- Filter washing

- _____ Manual washing: 'Valid' to start washing
- _____ Washing: 70 secs
- _____ Rinsing: 20 secs

- Disinfectant

- _____ mode: AUTO, OFF
- _____ Set-point: 650 mV
- _____ Type: PUMP, ELECTROLYSIS, PEROXIDE, WEEK, DAY
- _____ Stop threshold: 16 °C
- _____ Injection: 15 secs (every 15 mins) (PUMP mode only)
- _____ Pool volume: 48 m³ (PEROXIDE mode only)
- _____ Dosing pump: 1.0 l/h (PEROXIDE mode only)
- _____ Vol/week: 0.4 l (PEROXIDE mode only)
- _____ Comp. temp.: 1.0 (PEROXIDE mode only)
- _____ Max. volume: 0.5 l/d (PEROXIDE & PUMP modes only)
- _____ Alert range: 100
- _____ (if the set point is 650 mV, minimum alert = 650-100 = 550 mV, maximum alert = 650+100 = 750 mV)
- _____ Priming: ACTIVE (while OK button is held down)

- pH

- _____ mode: AUTO, OFF
- _____ Set point: 7.2
- _____ Type: pH-, pH+
- _____ Stop threshold: 3 °C
- _____ Injection: 15 secs (every 15 mins)
- _____ Max. volume: 0.5 L/d
- _____ Alert range: 0.2 (if the set point is 7.2, minimum alert = 7.2-0.2 = 7.0, maximum alert = 7.2+0.2=7.4)
- _____ Priming: ACTIVE (while OK button is held down)

Navigation menus (2/2)

- Setting the time

└── Time: 7 hours
└── Minute: 45 min.

- Calibration

└── Temp. Water: 25.1 °C
└── Temp. air: 27.8 °C
└── pH: 7.0, pH: 4.0

- Information

└── Firmware version

- Languages

└── LANGUAGE: FRANCAIS, ENGLISH

- Update

└── Firmware update: 'insert the USB stick and hold down the Up key'

- Radio

└── Radio channel: 01 (set the same as Speedeo)

- History (press ESC KEY in the main menu)

└── DAY IN PROGRESS: Filtration: , disinfect: pH control.
└── DAILY HISTORY 1: Filtration: , disinfect: pH control

MAINTENANCE - Cleaning of the pH or ORP probe.

i Deposition of scale or suspended elements in the pool may occur. The probes are fragile measuring parts, they need to be carefully cleaned. In particular, do not scratch the platinised surfaces of the electrodes of the conductivity probe.

Physical cleaning of the probe if there is an object present in the protective cage:

Depending on the probe environment, organisms may grow and disrupt the measurement. It then becomes necessary to physically clean the end of the probe (pH or ORP).

1 Carefully unscrew the cage by hand

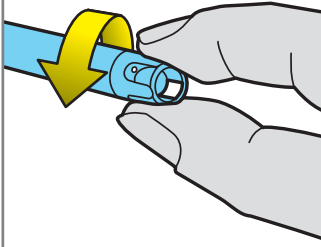

2 Using a toothbrush which has been dipped into white vinegar, gently brush the end of the probe until the foreign substance is fully removed.

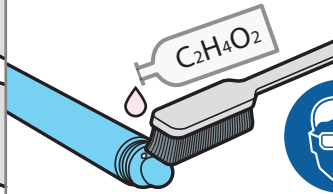

3 Rinse the end of the probe for 5 minutes generously under running water.

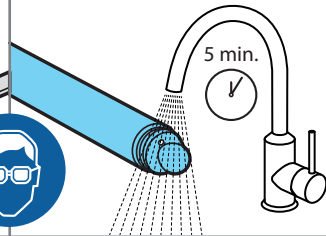

4 Carefully tighten the protective cage.

5 Calibrate the pH probe.

Chemical cleaning of the probe (no element is present in the protective cage):

1 For at least 10 minutes, dip the end of the probe into white vinegar.

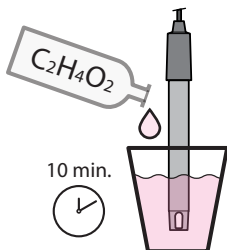

2 Rinse the end of the probe for 5 minutes generously under running water.

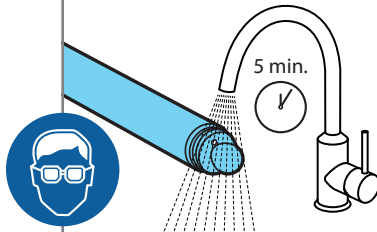

3 Calibrate the pH probe.



How to update the internal firmware



- 1.1 - Unzip the SoleoXXX.zip file to obtain the Soleo.bin file.
- 1.2 - Copy the soleo.bin file to the main folder of the USB stick formatted in FAT 16 or FAT 32.

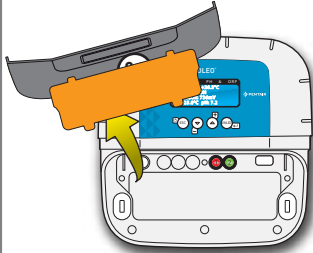

- 2.1 - Remove the soft cover, then remove the orange cover
- !! DO NOT TOUCH THE ELECTRICAL CONNECTIONS. RISK OF ELECTROCUTION! ONLY PROFESSIONALS AUTHORISED TO WORK WITH LIVE INSTALLATIONS MAY WORK ON THE CONNECTED DEVICE WITHOUT A SAFETY COVER.**

Home menu > Update menu :

Firmware update
Insert the USB stick and
hold down the
Up key

- 3.1 - Select the update menu

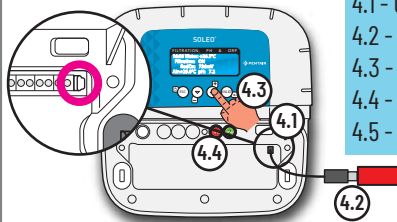

- 4.1 - Connect the USB cable supplied to the mini USB connector.
- 4.2 - Connect the USB stick to the end of the USB cable
- 4.3 - Press on the "up arrow / +" for more than 1 sec.
- 4.4 - The red and green indicators light up.
- 4.5 - Wait for the green indicator to remain off for 5 sec.

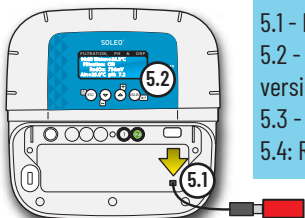

- 5.1 - Disconnect the USB stick (the green indicator lights up)
- 5.2 - In the main menu at the bottom, under Information, read the version no.: X.X and check that it has changed.
- 5.3 - Replace the orange safety cover
- 5.4: Replace the soft cover.

Variations in the RedOx (ORP) according to the pH and the chlorine rate in water without a stabiliser at a temperature of 18°C.

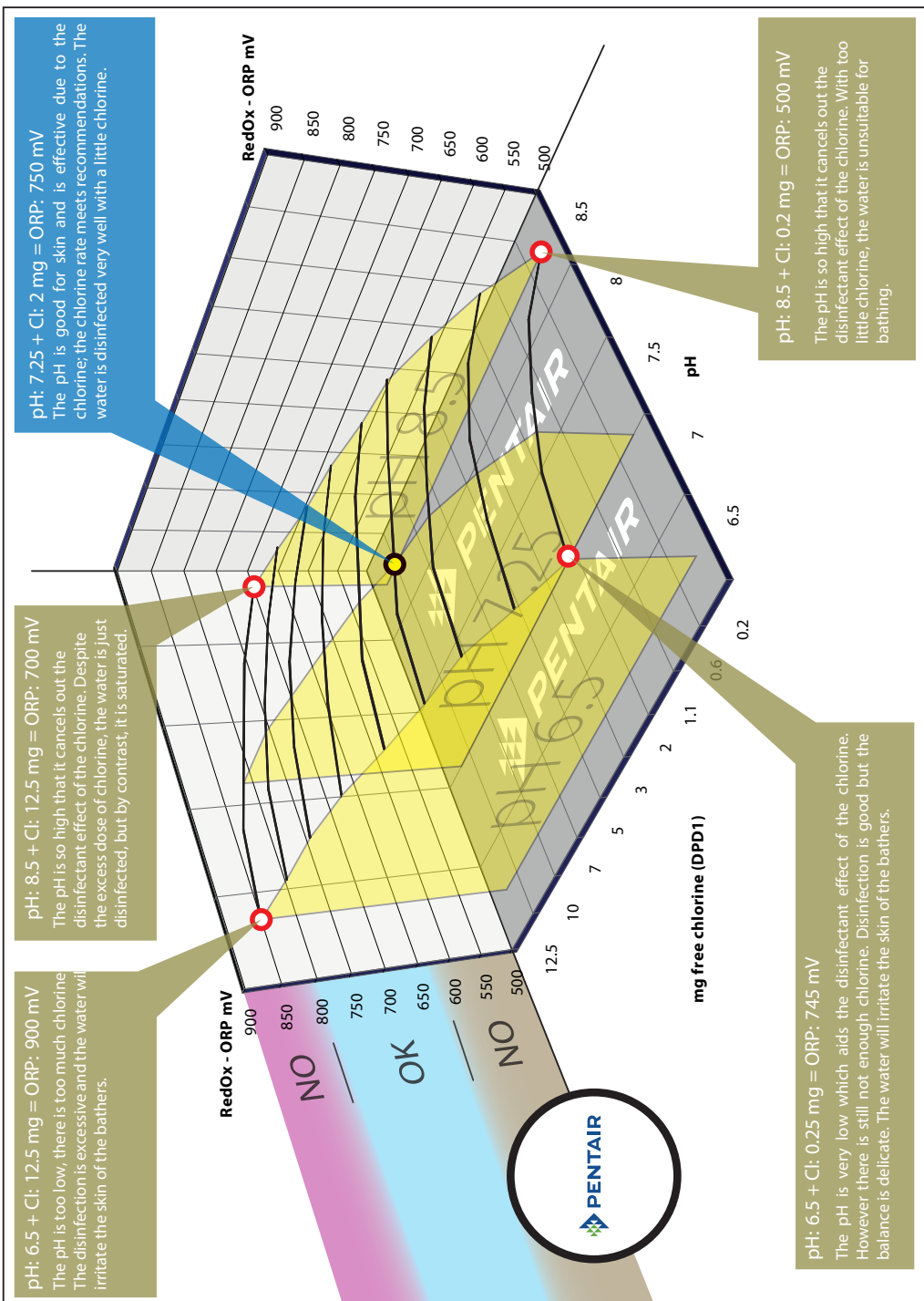

pH: 7.25 + Cl: 2 mg = ORP: 750 mV
 The pH is good for skin and is effective due to the chlorine; the chlorine rate meets recommendations. The water is disinfected very well with a little chlorine.

pH: 8.5 + Cl: 12.5 mg = ORP: 700 mV
 The pH is so high that it cancels out the disinfectant effect of the chlorine. Despite the excess dose of chlorine, the water is just disinfected, but by contrast, it is saturated.

pH: 6.5 + Cl: 12.5 mg = ORP: 900 mV
 The pH is too low, there is too much chlorine. The disinfection is excessive and the water will irritate the skin of the bathers.

pH: 8.5 + Cl: 0.2 mg = ORP: 500 mV
 The pH is so high that it cancels out the disinfectant effect of the chlorine. With too little chlorine, the water is unsuitable for bathing.

pH: 6.5 + Cl: 0.25 mg = ORP: 745 mV
 The pH is very low which aids the disinfectant effect of the chlorine. However there is still not enough chlorine. Disinfection is good but the balance is delicate. The water will irritate the skin of the bathers.



PENTAIR INTERNATIONAL LLC,

Ave. de Sevellin 18, CH-1004 - LAUSANNE, Switzerland

Copyright – Limited Licence: except as specifically permitted herein, no portion of the content of this document may be reproduced in any form or by any means without the prior written permission of Pentair International SRL.